

Product Reference Sheet

18-8 Stainless Steel Washer

MAR-SWF03100

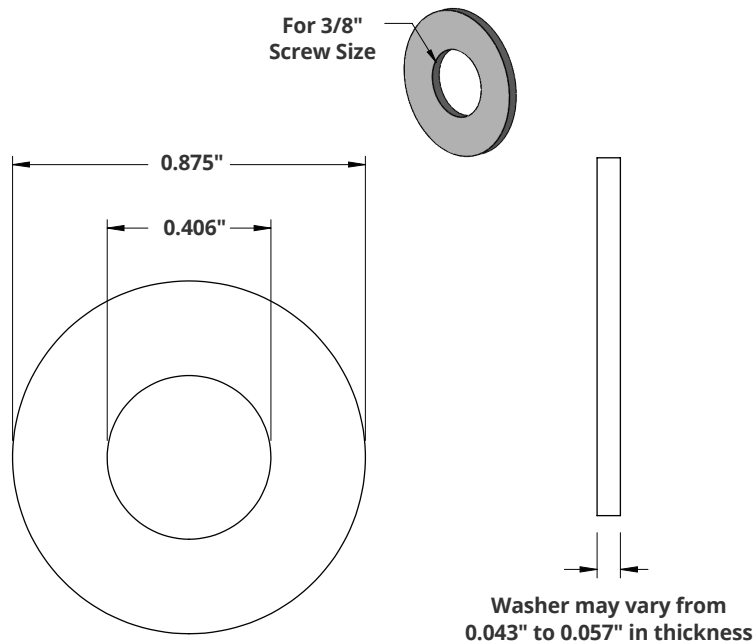

Specifications

Product Features

Part Number	MAR-SWF03100
Description	3/8" Flat Washer, Stainless Steel
Material	18-8 Stainless Steel
For Screw Size	3/8"
I.D.	0.41"
O.D.	0.816"
Thickness	0.065"
Specification	ASME B18.21.1
Country of Origin	India or China